



PORTES COULISSANTES, ROULEMENTS

CHAPITRE 7

- Profil aluminium sur mesure p. 2
- Profil pour plan de travail p. 4
- Façades cadre alu p. 5
- Accessoires portes de placard p. 6
- Kits spéciaux d'aménagements de penderie p. 7



PROFIL ALUMINIUM SUR MESURE

07010100

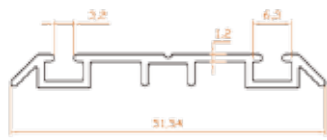

07010200

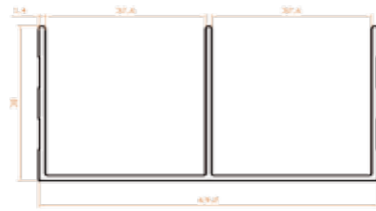

07010300

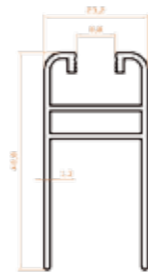

07011000



07011100



07011200



07010400

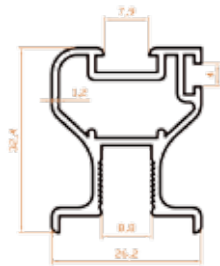

07010500

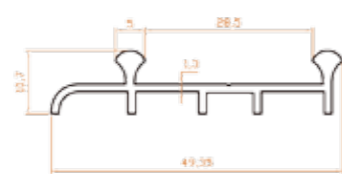

07010600

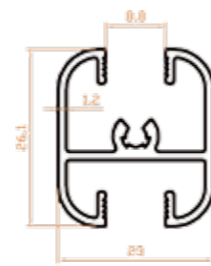

07011300



07011400



07011500



07010700

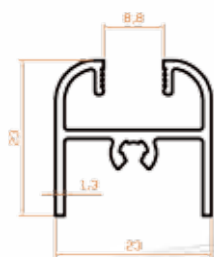

07010800

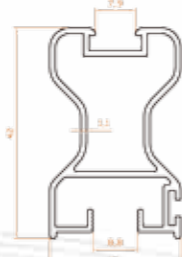

07010900

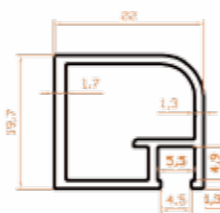

07011600



07011700



07011800



07011900



07012000



07012100



Nous développons des profils, sur cahier des charges, toutes les finitions sont disponibles ainsi que tous les usinages (perçages, découpes, etc...) l'emballage et le conditionnement seront conformes à vos contraintes de déchargement et de vos lignes d'assemblages.

Nous pouvons ajouter à nos productions, toutes pièces plastiques, visseries, caoutchouc, pièces acier, inox et vos notices de montages.

07020100

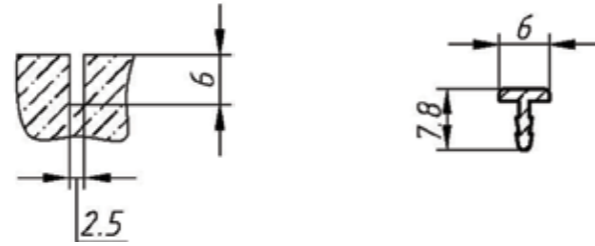

07020200

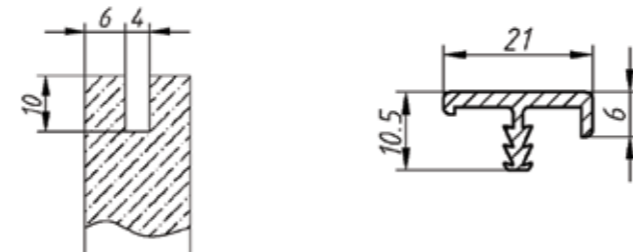

07020300

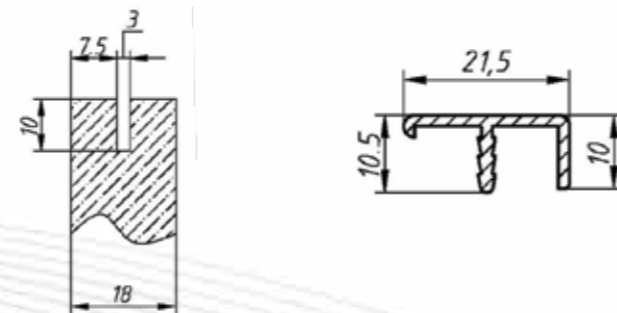

07020400

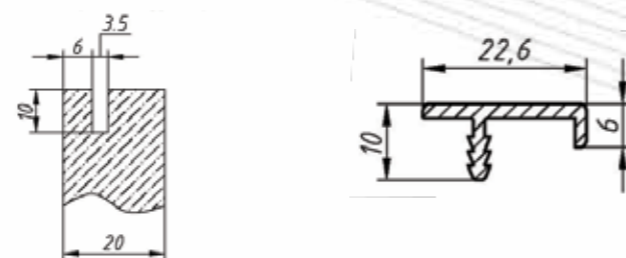

07030100

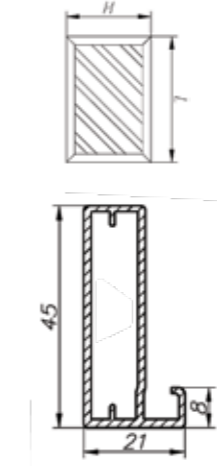

Accessoires

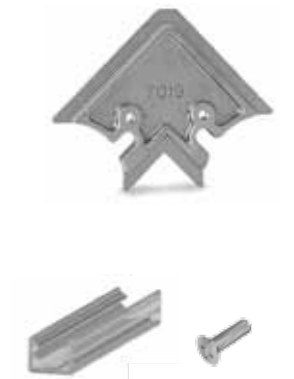

07030200

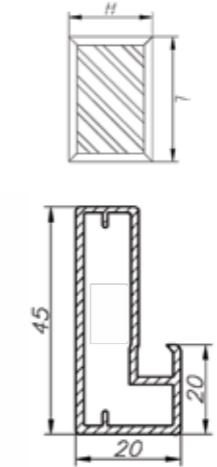

Accessoires



07030300

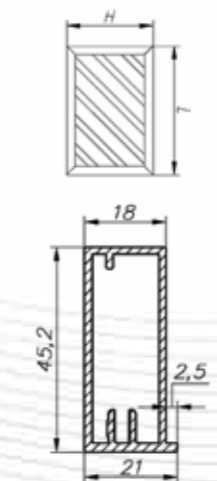

Accessoires



ACCESSOIRES PORTES DE PLACARD

07040100

Amortisseur pour porte de placard



07040200

Brosses

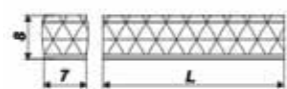

Références	Hauteur de poil (mm)	Largeur de base adhésive (mm)
07040200	4	8
07040201	8	6
07040202	10	7

07040300

Roulement



07040400

Roulement



07040500

Roulement



07040600

Roulement



KITS SPÉCIAUX D'AMÉNAGEMENT DE PENDERIE

07050100

Kits spéciaux d'installation de penderie



Permet la pose de portes coulissantes sous des combles ou un escalier. Les sabots articulés livrés dans le kit permettent un ajustement précis des rails tenant compte de la pente (rattrapage des angles de 30 à 90°).

Le kit contient : 2 sabots supérieurs, 2 sabots inférieurs, 4 vis de fixation.

07050200

Kit de rattrapage ou kit imposte (ou réducteur de plafond)



Permet de compenser l'écart (de 127 mm à 457 mm) entre le haut des portes de placard et le plafond. Ce kit se base sur la fixation d'un imposte au dessus des portes coulissantes. D'une manière générale, il faut 3 kits pour 2 portes, 4 kits pour 3 portes.

Le kit contient : 2 sabots universels, 2 grandes vis avec chevilles universelles, 1 barre et 4 vis de fixation.

